

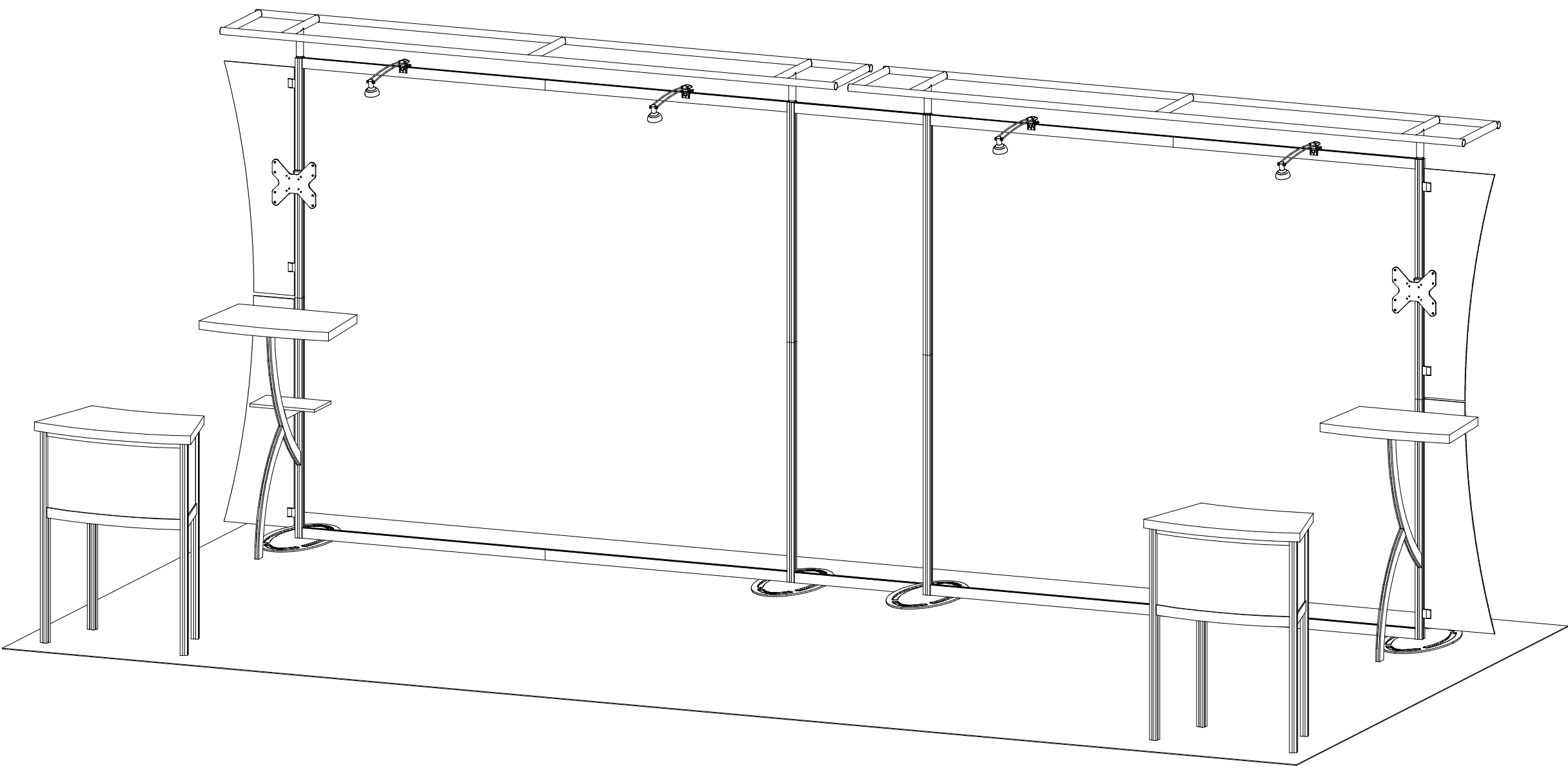

Plan View

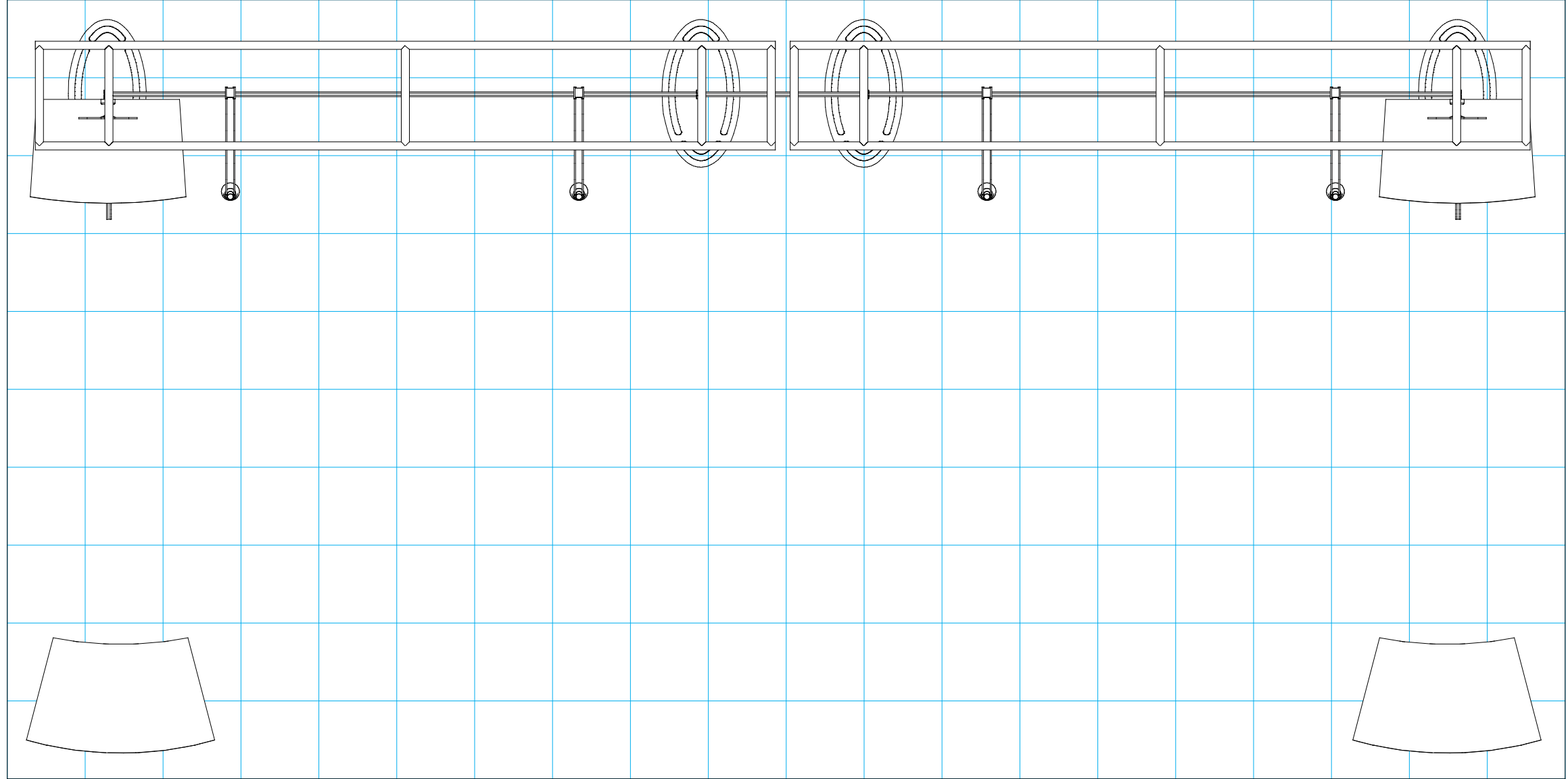

SETUP INSTRUCTIONS



 = 1 sq foot

General Setup Instructions

- Read entire setup instruction manual prior to unpacking parts and pieces.
- The setup instructions are created specifically for this configuration.
- Setup instructions are laid out sequentially in steps, including exploded views with detailed explanation for assembly.

Cleaning & Packing

- For Cleaning Metal, Plex, & Laminate Parts: Use a **MILD NON-ABRASIVE** cleanser and soft cloth/paper towel to clean all surfaces.
- Keep exhibit components away from heat and prolonged sun exposure.
Heat and UV exposure will warp and fade components.
- Retain all provided Packing Materials. All provided packing materials are for ease of repacking & component protection.

Disassembly

- For loss prevention, tighten all set screws and locks during disassembly.



Hex Tool - Essential for Assembly

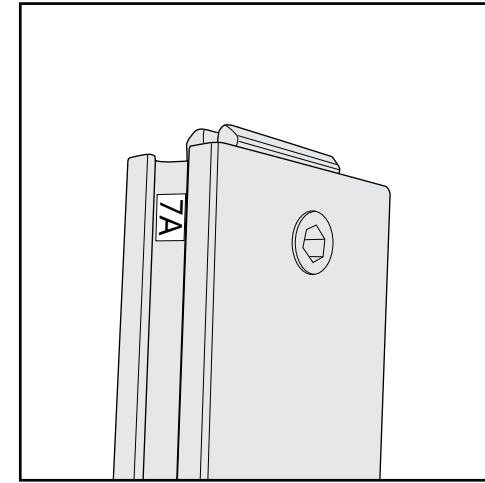

Part Identification - Numbering



Spline Connection



Base Plate & Extrusion Connection



Extrusion & Lock Connection



Engaged Lock



WARNING

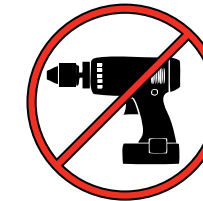

DO NOT USE POWER TOOLS

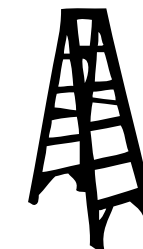

LADDERS OR LIFTS
MAY BE REQUIRED



ALL CONNECTIONS MUST
BE TIGHTLY SECURED



1) Mounting plate & wing nuts, in packed position.

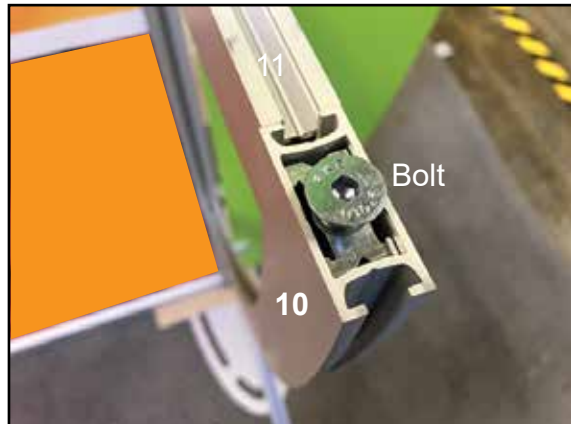

2) Mounting plate bolt in, packed position.

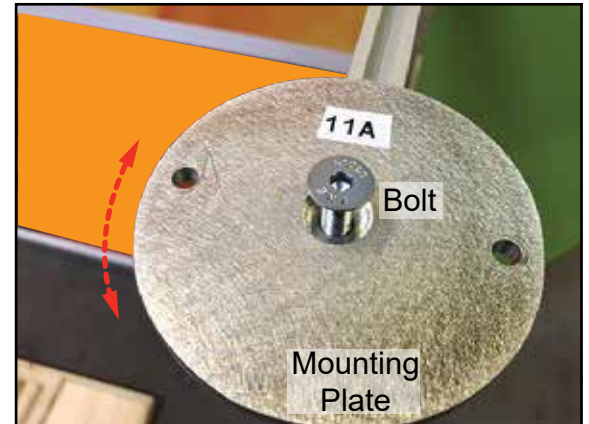

3) Place mounting plate onto [10] then tighten bolt, part way, allowing some rotation for final positioning.

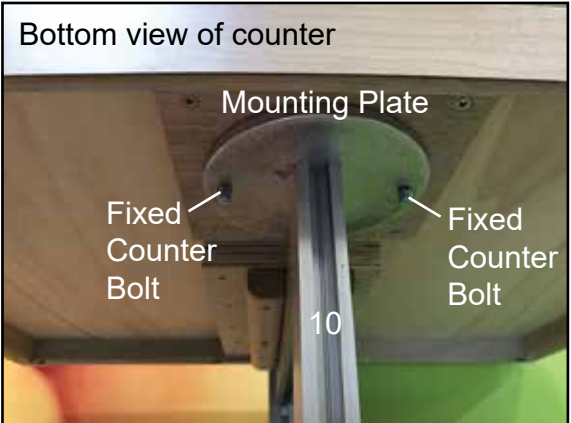

4) Place fixed counter bolts into mounting plate, then lift counter to re-tighten bolt.

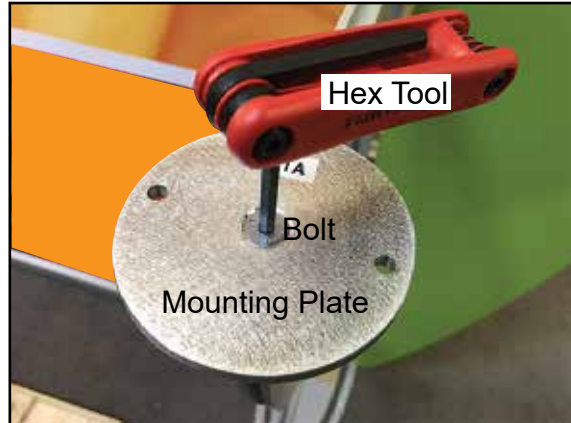

5) Tighten bolt, using hex tool, to secure.



6) Place fixed counter bolts into mounting plate, then secure using wing nuts.

Completed Assembly

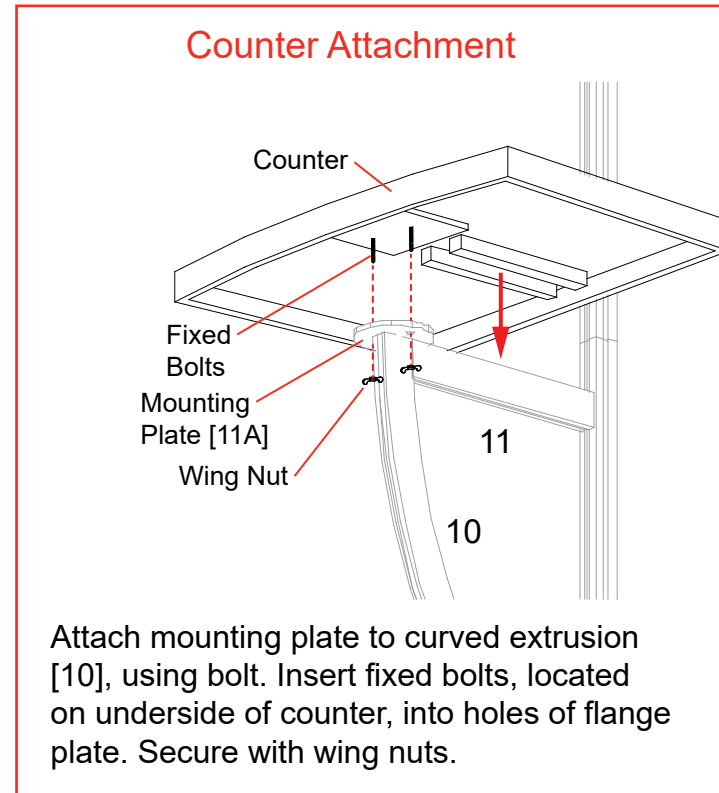

Keep mounting plate [11A] and wing nuts attached to counter, when packing.

Keep bolt attached to [10], when packing.

Top View of Each Level

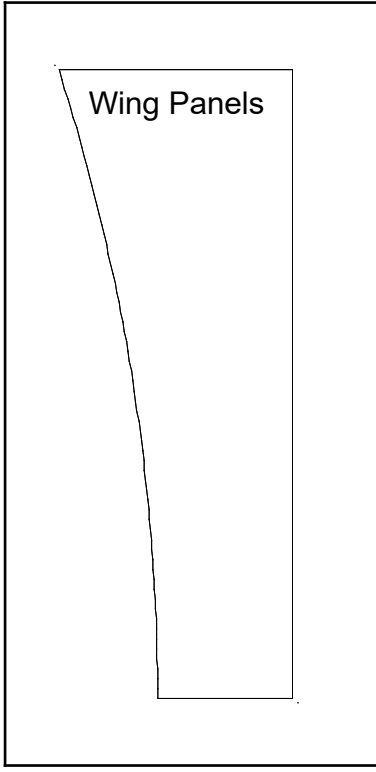

Level 1 (Bottom Level)

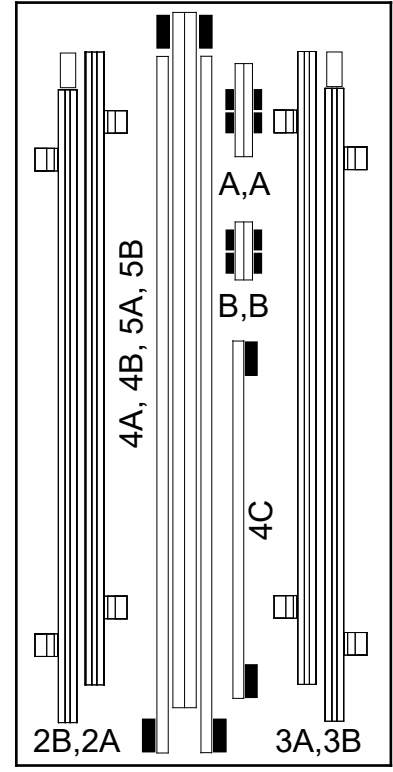

Level 2

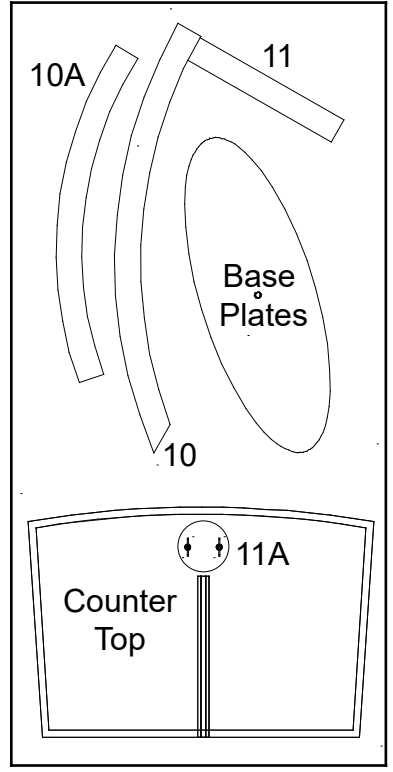

Level 3

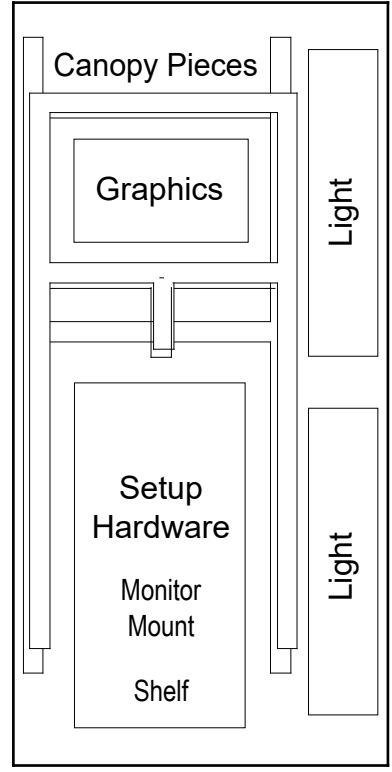

Level 4

Top View of Each Level

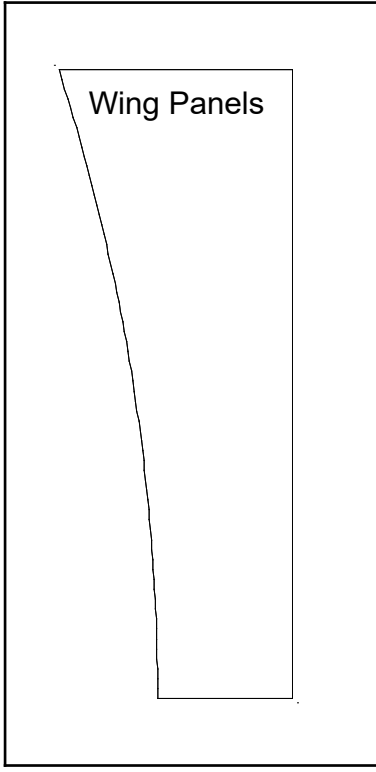

Level 1 (Bottom Level)

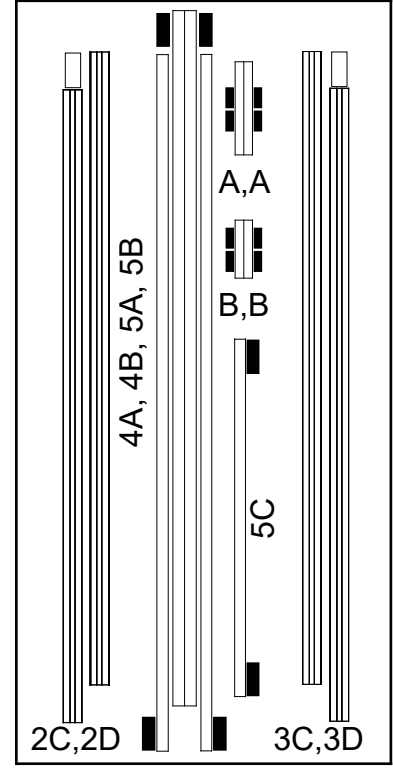

Level 2

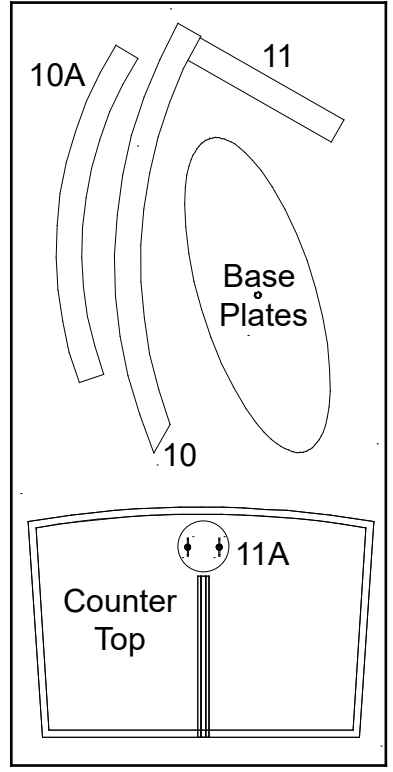

Level 3

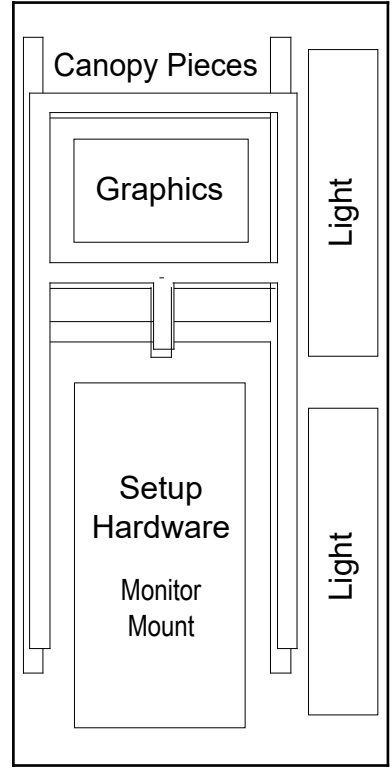

Level 4

Top View of Each Level

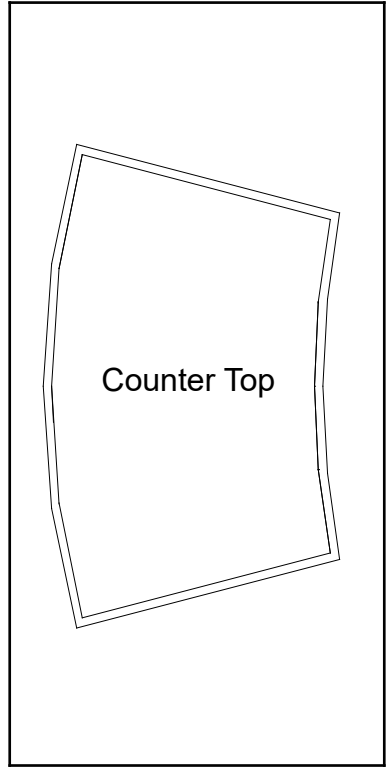

Level 1 (Bottom Level)

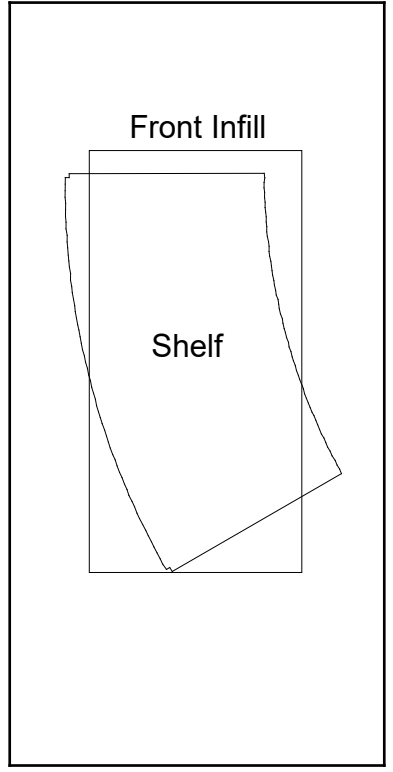

Level 2

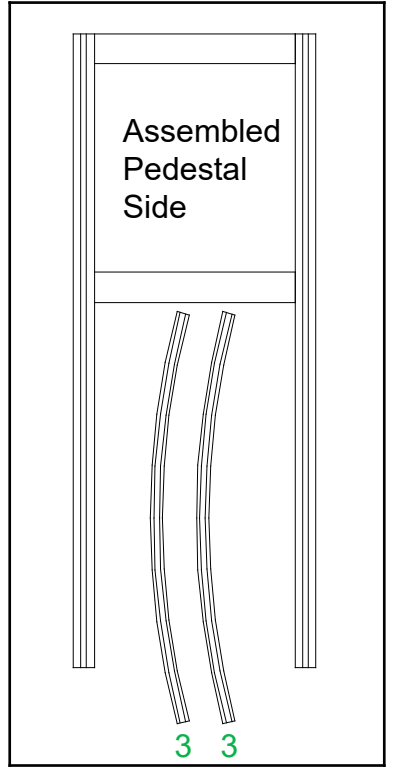

Level 3

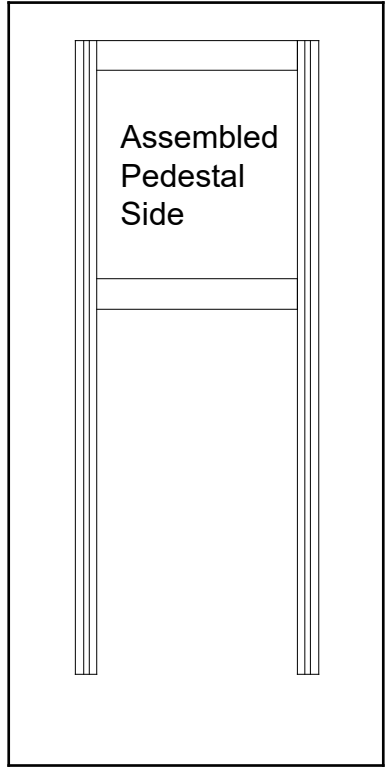

Level 4

Top View of Each Level

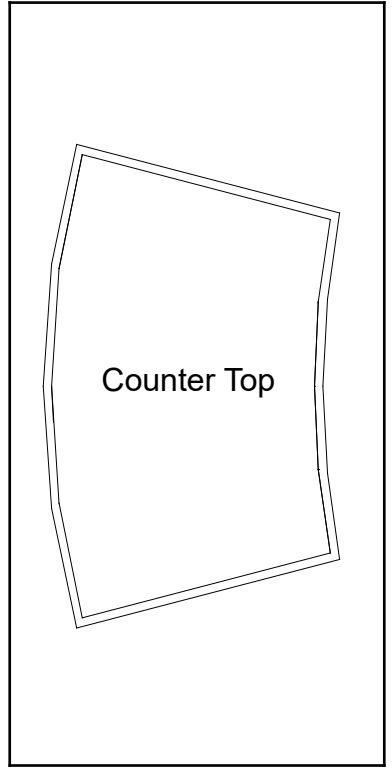

Level 1 (Bottom Level)

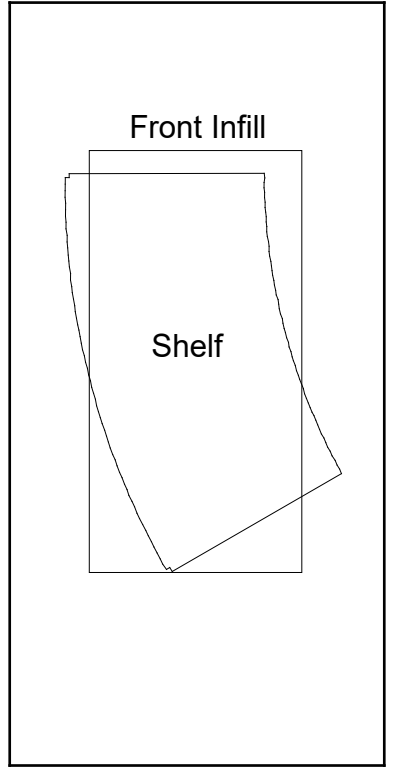

Level 2

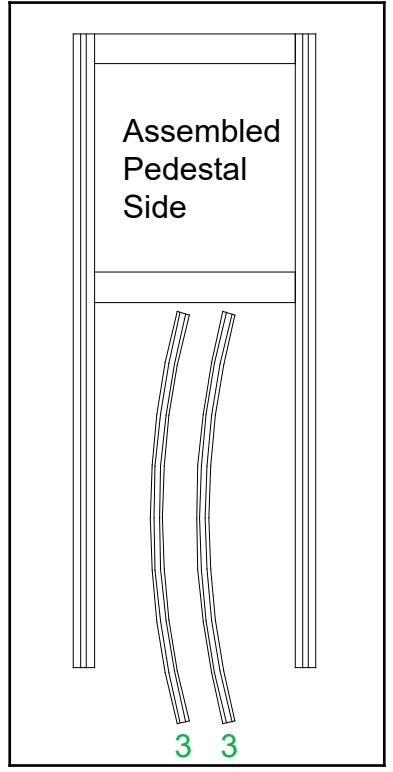

Level 3

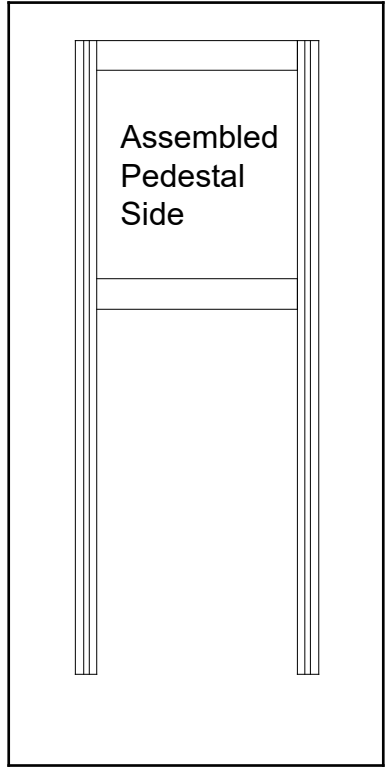

Level 4

Item	Qty.	Description
1	2	Base Plate
2A,2B	1,1	42" S40 Vertical Extrusion w/ A10 Clamps
3A,3B	1,1	42" S40 Vertical Extrusion w/ A10 Clamps
2C,2D	1,1	42" S40 Vertical Extrusion
3C,3D	1,1	42" S40 Vertical Extrusion
4A,4B	2,2	45" Z45 Horizontal Extrusion
5A,5B	2,2	45" Z45 Horizontal Extrusion
4C,5C	1,1	24" Z45 Horizontal Extrusion

- Steps:
- 1) Attach base plates [1] lower verticals [2A] [3A] [2C] and [3C], using bolts.
 - 2) Connect verticals [2A to 2B] [3A to 3B] [2C to 2D] and [3C to 3D], using connection bars [B]. See [Straight Connection with Knobs](#) detail.
 - 3) Connect horizontals [4A to 4B] and [5A to 5B], using connection bars [A]. See [Straight Connection with Knobs](#) detail.
 - 4) Attach vertical assemblies [2A/2B] [3A/3B] [2C/2D] and [3C/3D] with horizontal assemblies [4A/4B] and [5A/5B]. See [Corner Connection with Knob](#) detail.
 - 5) Connect left & right assemblies using horizontals [4C,5C].
 - 6) Attach graphic to Velcro on back of assembled Backwall.

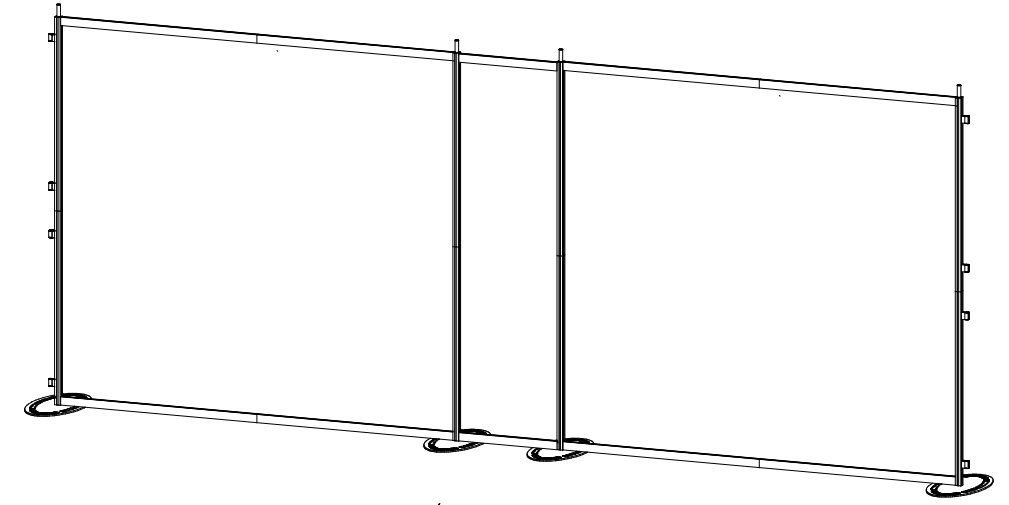

When Assembled

★ **Corner Connection with Knob**



Turn knob clockwise to tighten lock.

Do not over tighten Knobs

◆ **Straight Connection with Knobs**

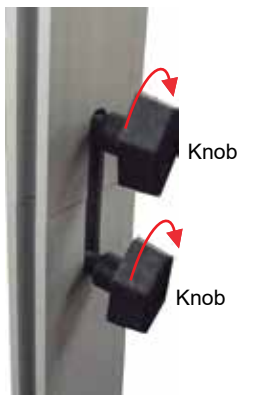

Slide connection bar between extrusions, then turn knobs clockwise to tighten lock.

Do not over tighten Knobs

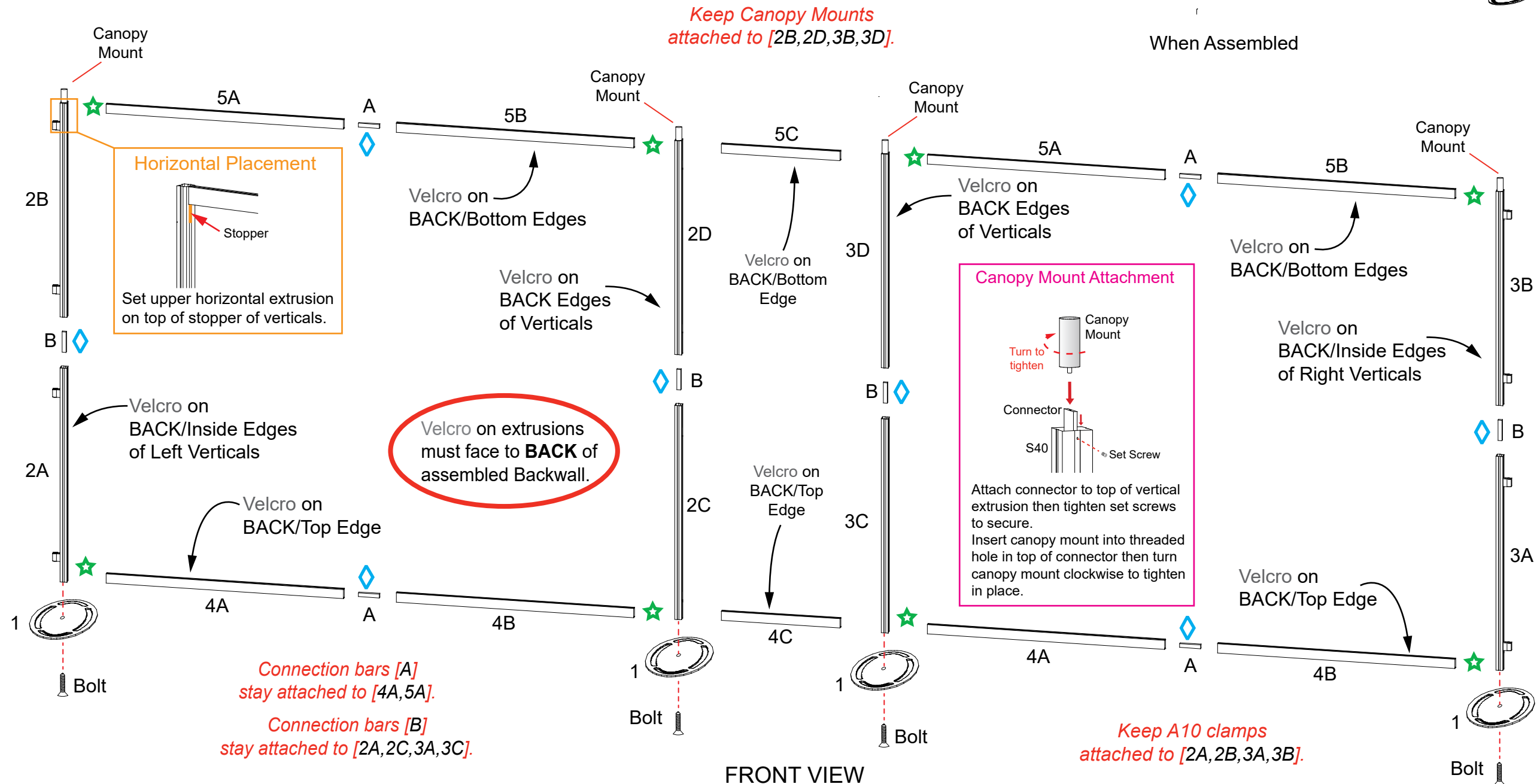

Steps:

- 1) Connect lights to top horizontal extrusions. See **Light Connection** detail.
- 2) Attach extrusions [10/11] to verticals [2A] & [3A]; connect shelf to vertical [2A].
- 3) Attach support legs [10A] to curved extrusions [10].
- 4) Attach flange plates [11A] to top of curved extrusions [10], using bolts.
- 5) Attach counter tops to counter mounting plates [11A]. See Counter Assembly page.
- 6) Attach Wings to A10 clamps. See **Clamp Attachment** detail.
- 7) Attach Monitor Mounts to verticals [2B] & [3B]. See **Monitor Mount Attachment** detail.

Item	Qty.	Description
10	2	30.2" Curved Extrusion
10A	2	Support Leg
11	2	12.184" Horizontal Extrusion
11A	2	Counter Mounting Plate

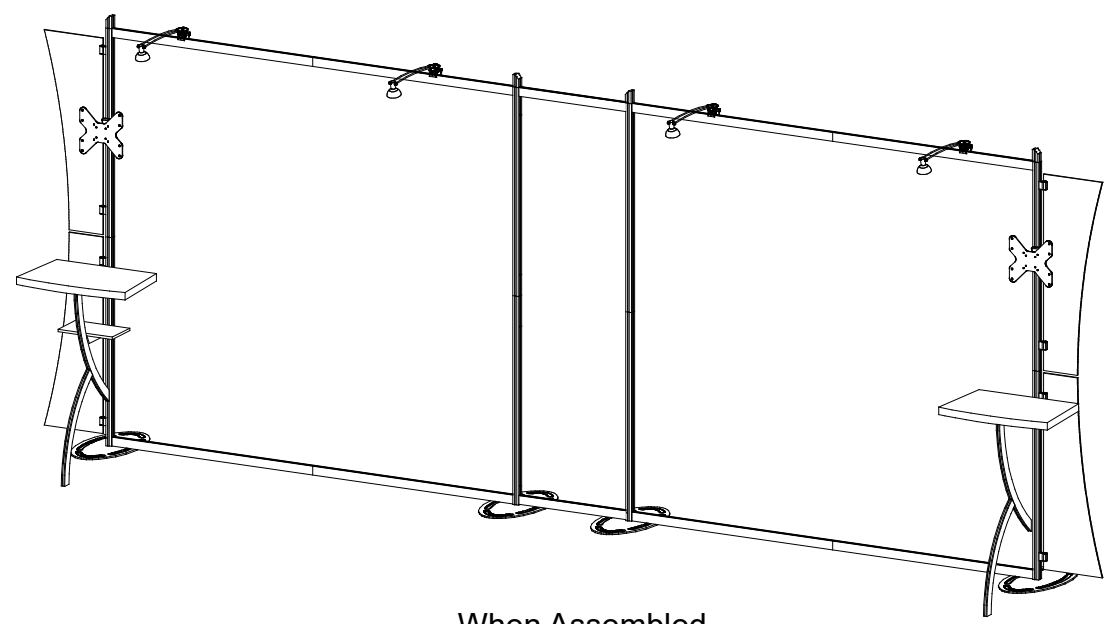

When Assembled

* Monitor Mount Attachment

Slide V4 Connectors into groove of Extrusion. Tighten Set Screws to secure connectors in place.

Attach Monitor Mount back piece to Extrusion, using bolts.

Then slide monitor mount into back piece.

* Light Connection

Slide light onto clip then lock clip into groove of horizontal extrusion.

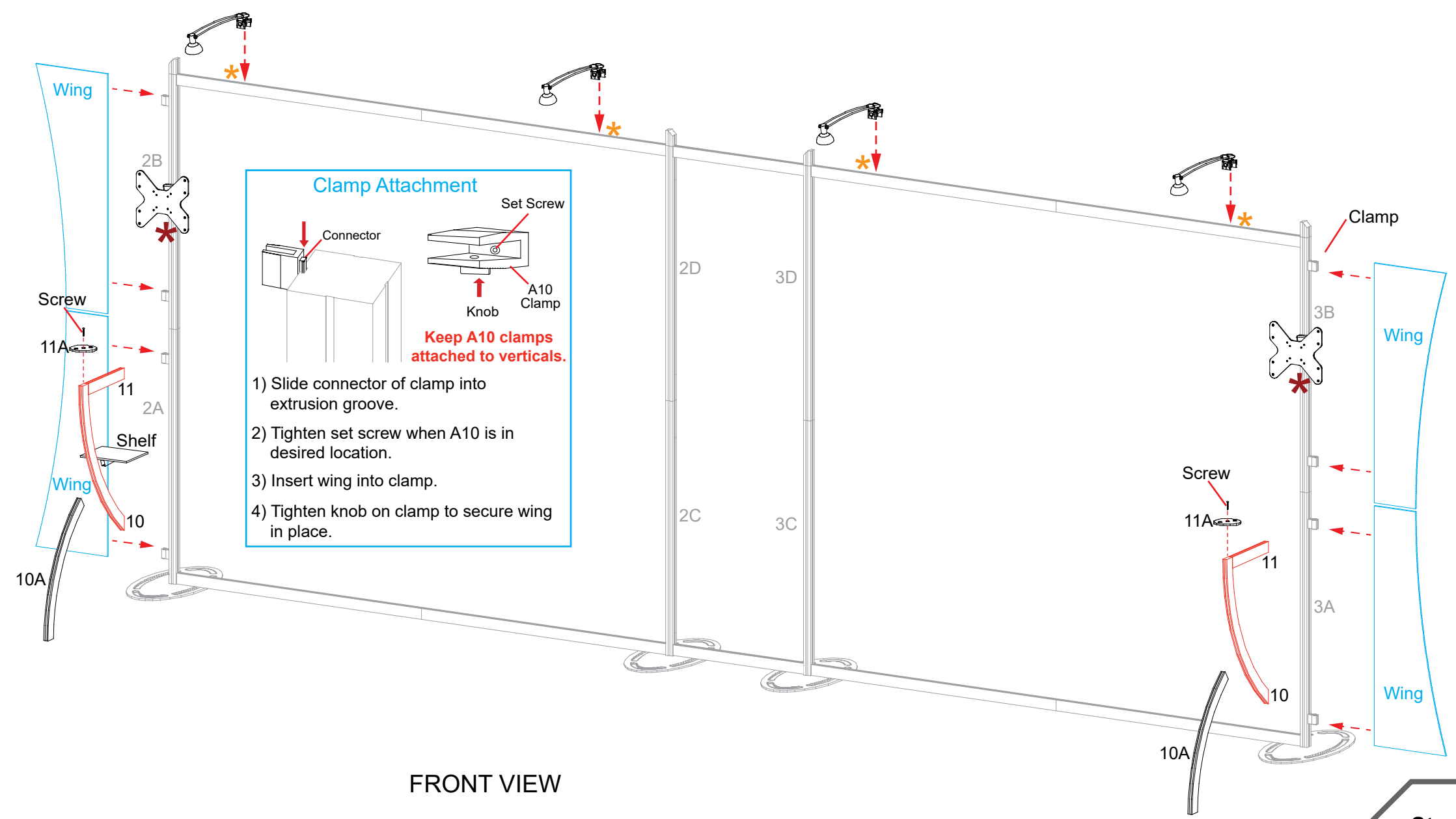

FRONT VIEW

AERO

- Steps:
- 1) Connect canopy pieces together as shown.
 - 2) Apply pillow case graphic to assembled canopy.

Using Your Setup Instructions

The Aero Setup Instructions are created specifically for your configuration. The instructions include an exploded view of the frame which is sequentially labeled. We encourage you to review the instructions before attempting to assemble your exhibit.

Connections are kept very simple; no tools required. Everything assembles with push-button connectors.

Cleaning and Packing Your Display

- 1) Use care when cleaning aluminum extrusion or acrylic inserts. Use only non-abrasive cleaners.
- 2) Retain all packing material. It will make re-packing much easier and will reduce the likelihood of shipping damage.

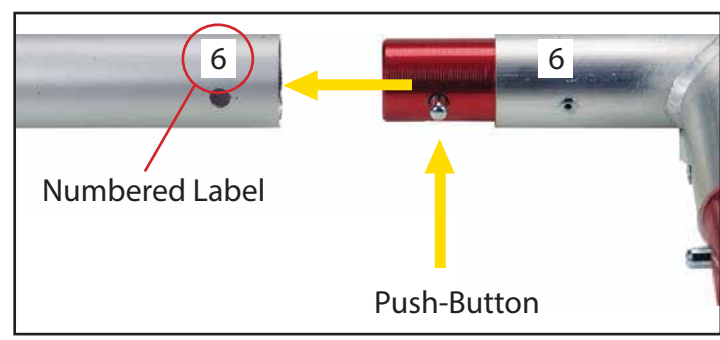
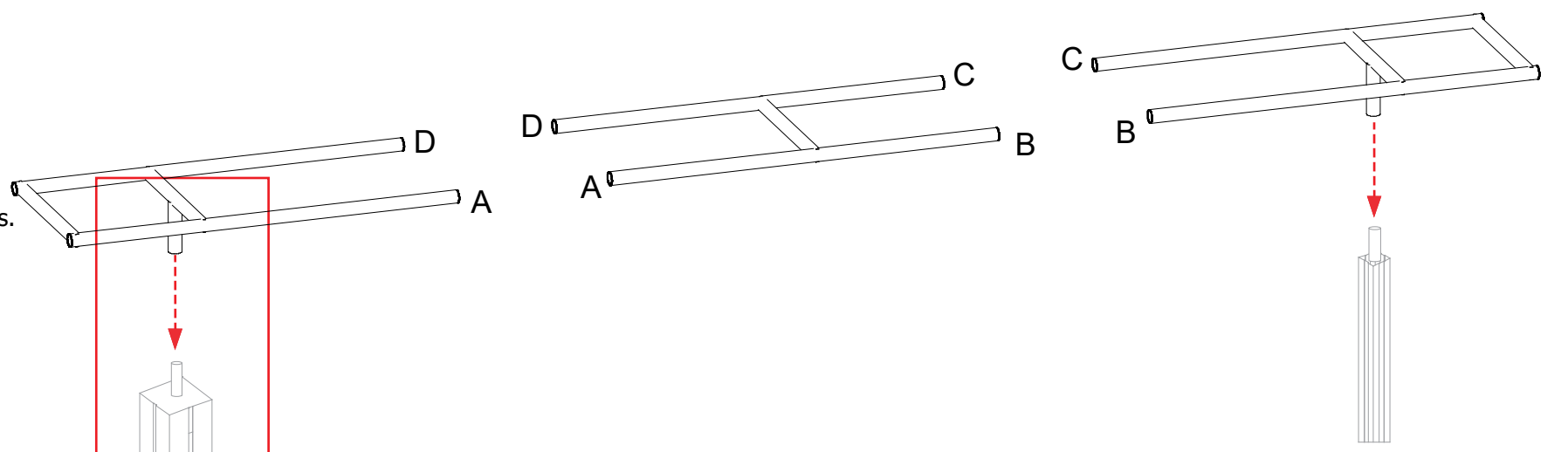

Connections are made by holding the button down and sliding the red tube into opposing tube until button locks into the hole of the opposing tube. To disassemble, push button and pull or twist extrusions apart.

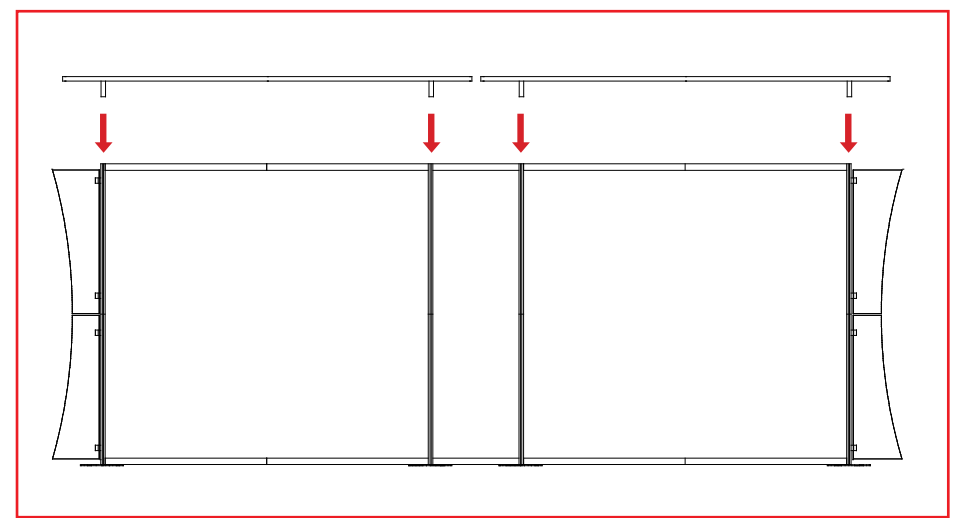
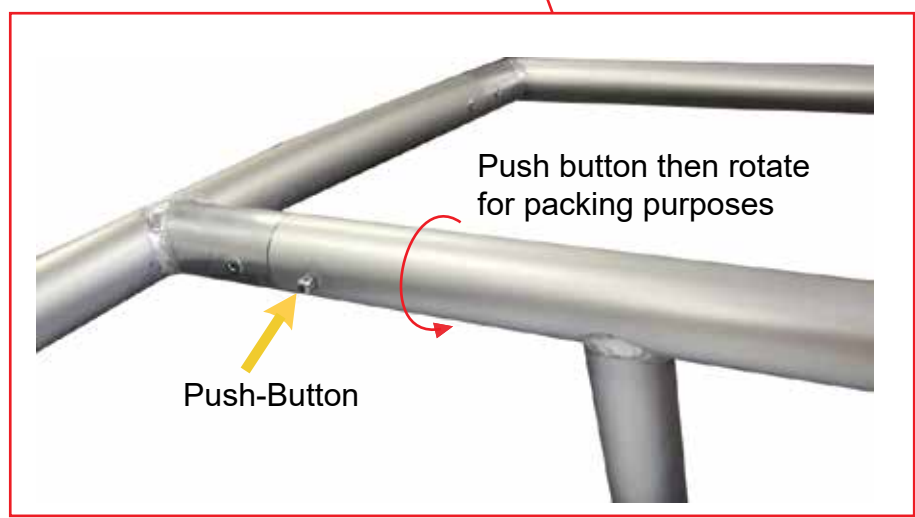
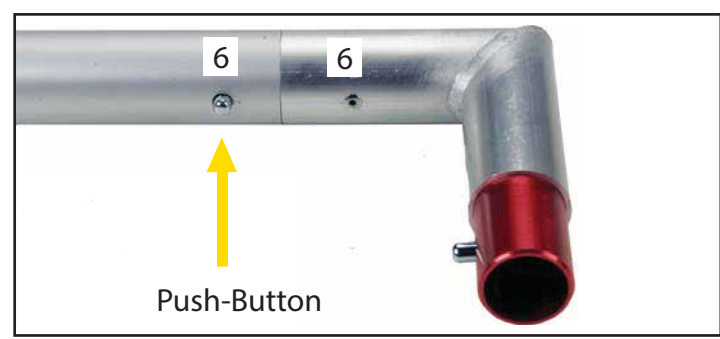

Item	Qty	Description
1	8	38" S40 Vertical Extrusion
2,2A	4,4	12" Z45 Horizontal Extrusion
3	4	25" Z45 Horizontal Extrusion

Steps

- 1) Attach horizontals [2] and [2A] between verticals [1], with infills between.
- 2) Attach curved horizontals [3] between front verticals [1], with infill between.
- 3) Place shelf on lip of extrusions [2]. See [Extrusion Lip](#) detail.
- 4) Set pedestal top on top of extrusions [2A] and [3].

Repeat steps 1 through 4 for other pedestal assembly.

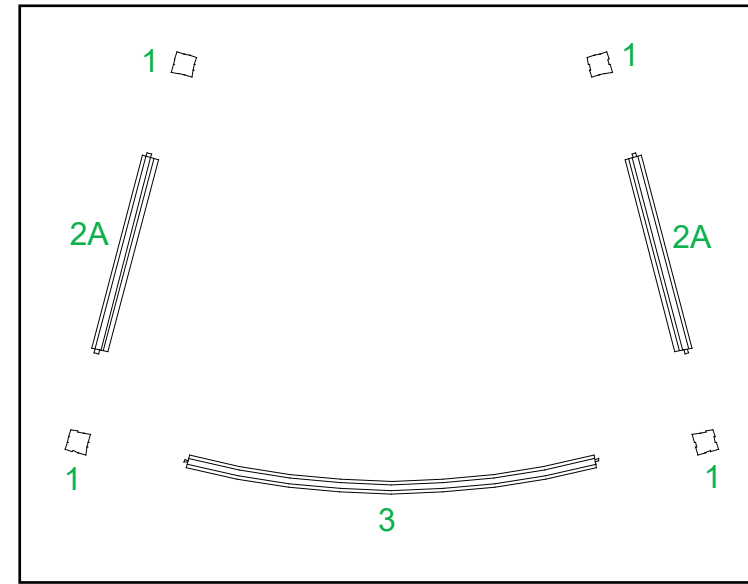

Top View

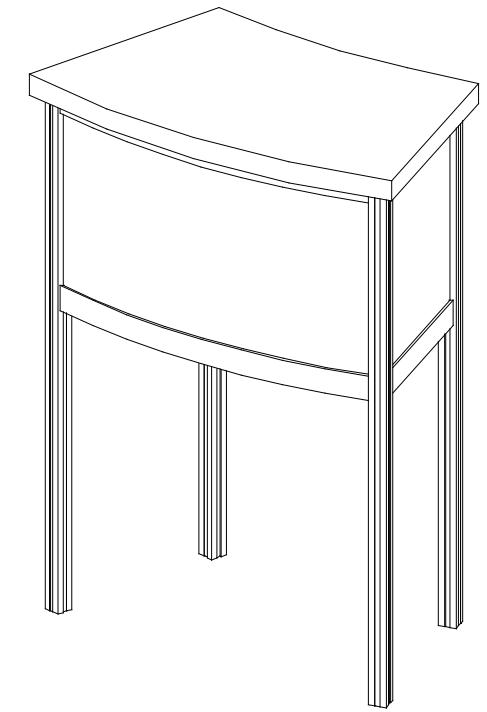

Completed Pedestal Assembly
Qty. 2

